

JC050005

Toughflood Commercial

Toughflood Commercial 70W 6300lm 90lpcW 4000K IP65 Black

Features & Benefits

- Up to 90 LpcW
- Driver less technology, instant start up
- Polycarbonate Diffuser: Suitable for food preparation
- 2M pre-wired H05RN-F cable for exterior applications
- ADC12 die-cast aluminium body, corrosion resistant, lightweight for easier installation
- Easy access installation with 55° angled Galvanized steel bracket
- 110° beam angle



RATING



CLASS I



BEAM



CRI:RA



WARRANTY



RATING

General Information

Mounting

Wall

Environment

Outdoor

Product Range

Commercial Exterior

Trade Name

Toughflood

Color Finish

Black

Product Shape

Rectangular

Product Weight(kg)

1.15

Overall Dimensions

255 x 229 x 36mm

Light Source

LED

Light Source Features

Neutral White

Recommended Product Location

Exterior, general security lighting

Method Of Fix

Mounting Bracket with suitable fixings (not supplied)

IP Rating

IP65

Origin of manufacturer

China

Warranty

2 years standard warranty extends to 3 years when registered within the first year of purchase (See Website for terms and conditions)

Driver Manufacturer

No driver, mains LED Chips

LED Manufacturer/Type

Optoelectronics 2835

Electrical

Voltage Rating	220-240
Primary Running Current(Amp)	0.35
Operating Frequency Hz	50/60Hz
Luminaire Circuit Wattage	70
Class	I
EMC Compliant (EN55015)	Yes
Power Factor Correction	0.9
Input Electrical Connections	Live, Earth and Neutral
Dimmable	No
Supplied cable rating	2M pre-wired H05RN-F

Thermals

Operating Temperature Range °C	-20 to +40
--------------------------------	-------------------

Performance Data

LED Life (Hours)	54000
------------------	--------------

Hours life stated is an indication of expected L70 chip and light output calculations when operating in optimum conditions. Product warranty period supports the full product during the term given. The L70 hours expectancy is not correlated with the full product warranty term, nor is it a representation of lumen depreciation during the warranty period.

Energy Rating	This product contains a light source of energy efficiency class F
Actual Lumen Output	6300
Lumens Per Circuit Watt	90
Standard Deviation Colour Matching - SDCM	<6
Color Rendering Index	50-79
CRI: Ra	70
Correlated Color Temperature	4000K
Beam Angle °	110
LOR (Light Output Ratio) %	100
Photometry Available	Yes

Construction

Primary Material	ADC12 die-cast aluminium
Outer Diffuser	Opaque Polycarbonate

Packaging

Product carton overall dimensions(cm)	27.4 x 24.5 x 4.5 cm
Product Packaged Weight(kg)	1.3
Quantity Per Outer Carton	10
Outer carton(L)- cm	47.0
Outer carton(W)- cm	28.6

Outer carton(H)- cm
Outer carton Net weight- kg
Outer carton Gross weight- kg
Product Bar Code EAN-13 Number
Outer carton Bar Code ITF-14 Number

25.7
13.00kg
13.50kg
5052544105975
15052544105972

Standards & Approvals

Manufactured In Accordance To
CE Marked
UKCA Marked
Date code/Purchase order No.
WEEE Symbol
Certificate Of Conformity
Accredited Members

BS EN 60598-2015,2-1,2-5
Yes
Yes
Yes
Yes
Available on request
LIA, ISO9001-2015, ISO14001-2015

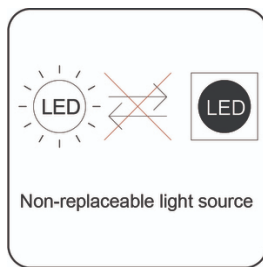
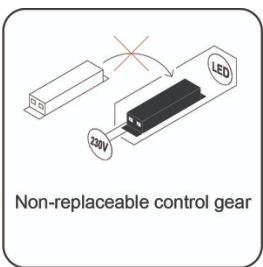
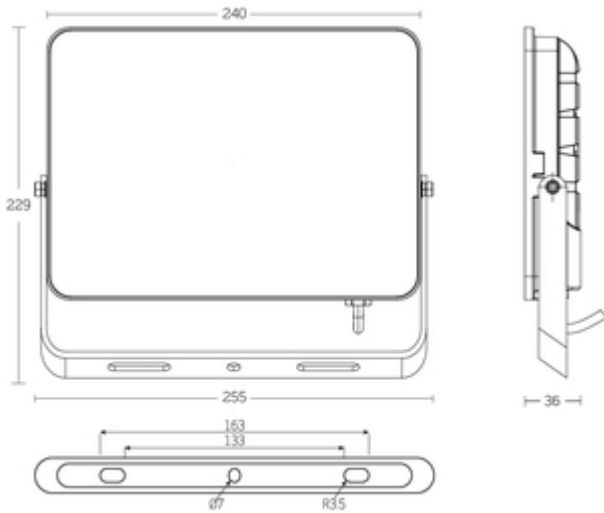

JCC Lighting LTD Innovation Centre, Beeding Close, Southern Cross Trading Estate, Bognor Regis, West Sussex PO22 9TS
Sales: 01243 838999 (8am to 5pm Monday to Friday) Fax: 01243 838998 | sales@jcc.co.uk | www.jcc.co.uk
Company Registration Number: 03044848 | VAT Number: 918544112

This document is uncontrolled if printed, all information is subject to change

Version 98 [02/11/2021]