

JC050006

## Toughflood Commercial

Toughflood Commercial 100W 8500lm 85lpcW 4000K IP65 Black

### Features & Benefits

- Up to 90 LpcW
- Driver less technology, instant start up
- Polycarbonate Diffuser: Suitable for food preparation
- 2M pre-wired H05RN-F cable for exterior applications
- ADC12 die-cast aluminium body, corrosion resistant, lightweight for easier installation
- Easy access installation with 55° angled Galvanized steel bracket
- 110° beam angle



RATING



WARRANTY



RATING



CLASS I



BEAM



CRI:RA

### General Information

Mounting

Environment

Product Range

Trade Name

Color Finish

Product Shape

Product Weight(kg)

Overall Dimensions

Light Source

Light Source Features

Recommended Product Location

Method Of Fix

IP Rating

Origin of manufacturer

Warranty

Driver Manufacturer

LED Manufacturer/Type

Wall

Outdoor

Commercial Exterior

Toughflood

Black

Rectangular

1.8

322 x 265 x 38mm

LED

Neutral White

Exterior, general security lighting

Mounting Bracket with suitable fixings (not supplied)

IP65

China

2 years standard warranty extends to 3 years when

registered within the first year of purchase (See Website for terms and conditions)

No driver, mains LED Chips

Optoelectronics 2835

## Electrical

Voltage Rating	<b>220-240</b>
Primary Running Current(Amp)	<b>0.51</b>
Operating Frequency Hz	<b>50/60Hz</b>
Luminaire Circuit Wattage	<b>100</b>
Class	<b>I</b>
EMC Compliant (EN55015)	<b>Yes</b>
Power Factor Correction	<b>0.9</b>
Input Electrical Connections	<b>Live, Earth and Neutral</b>
Dimmable	<b>No</b>
Supplied cable rating	<b>2M pre-wired H05RN-F</b>

## Thermals

Operating Temperature Range °C	<b>-20 to +40</b>
--------------------------------	-------------------

## Performance Data

LED Life (Hours)	<b>54000</b>
------------------	--------------

Hours life stated is an indication of expected L70 chip and light output calculations when operating in optimum conditions. Product warranty period supports the full product during the term given. The L70 hours expectancy is not correlated with the full product warranty term, nor is it a representation of lumen depreciation during the warranty period.

Energy Rating	<b>This product contains a light source of energy efficiency class F</b>
Actual Lumen Output	<b>8500</b>
Lumens Per Circuit Watt	<b>85</b>
Standard Deviation Colour Matching - SDCM	<b>&lt;6</b>
Color Rendering Index	<b>50-79</b>
CRI: Ra	<b>70</b>
Correlated Color Temperature	<b>4000K</b>
Beam Angle °	<b>110</b>
LOR (Light Output Ratio) %	<b>100</b>
Photometry Available	<b>Yes</b>

## Construction

Primary Material	<b>ADC12 die-cast aluminium</b>
Outer Diffuser	<b>Opaque Polycarbonate</b>

## Packaging

Product carton overall dimensions(cm)	<b>33 x 27 x 4.5 cm</b>
Product Packaged Weight(kg)	<b>2</b>
Quantity Per Outer Carton	<b>5</b>
Outer carton(L)- cm	<b>34.2</b>
Outer carton(W)- cm	<b>28.2</b>

Outer carton(H)- cm  
Outer carton Net weight- kg  
Outer carton Gross weight- kg  
Product Bar Code EAN-13 Number  
Outer carton Bar Code ITF-14 Number

24.5  
10.00kg  
10.50kg  
5052544105982  
15052544105989

## Standards & Approvals

Manufactured In Accordance To  
CE Marked  
UKCA Marked  
Date code/Purchase order No.  
WEEE Symbol  
Certificate Of Conformity  
Accredited Members

BS EN 60598-2015,2-1,2-5  
Yes  
Yes  
Yes  
Yes  
Available on request  
LIA, ISO9001-2015, ISO14001-2015

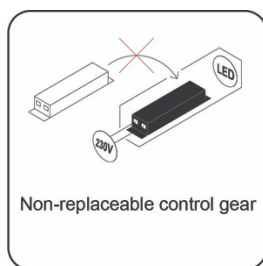
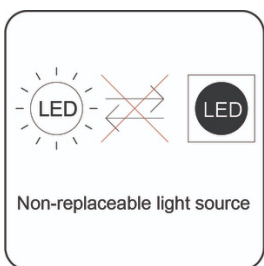
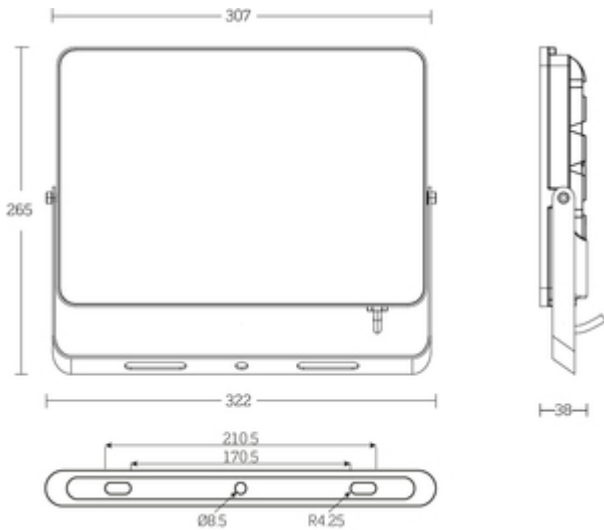

JCC Lighting LTD Innovation Centre, Beeding Close, Southern Cross Trading Estate, Bognor Regis, West Sussex PO22 9TS  
Sales: 01243 838999 (8am to 5pm Monday to Friday) Fax: 01243 838998 | [sales@jcc.co.uk](mailto:sales@jcc.co.uk) | [www.jcc.co.uk](http://www.jcc.co.uk)  
Company Registration Number: 03044848 | VAT Number: 918544112

This document is uncontrolled if printed, all information is subject to change

Version 97 [02/11/2021]